

TECHNICAL DATA SHEET - STANDARD TOOTH

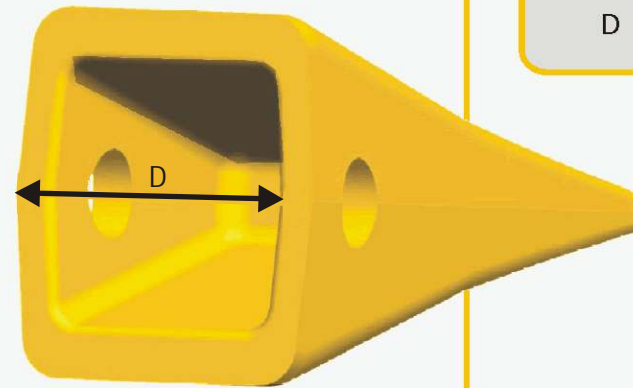
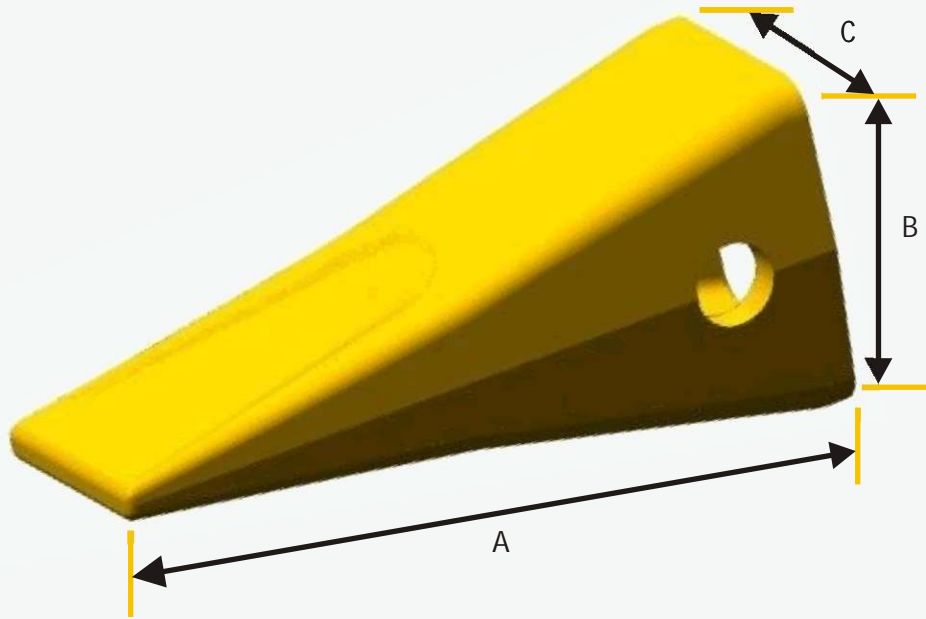

Label	Dimensions
A	145 mm
B	63 mm
C	55 mm
D	51 mm

NOTES:

CAST STEEL BUCKET TOOTH

IMPORTANT- PLEASE ENSURE YOU CHECK YOUR DIMENSIONS CAREFULLY BEFORE ORDERING TO ENSURE THE CORRECT PARTS ARE SUPPLIED.

